

HemoCue[®] Glucose 201 RT

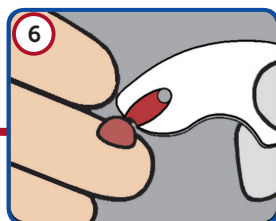

⌚ ≤40 s

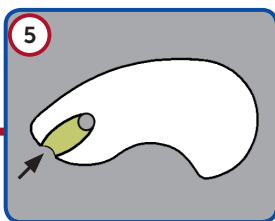
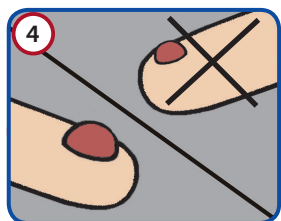
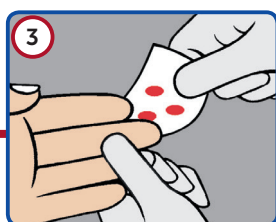
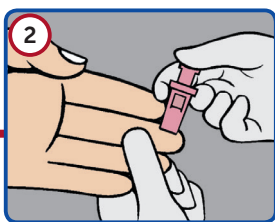
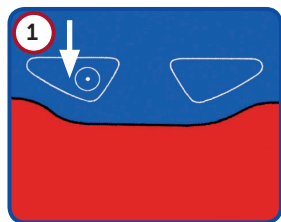
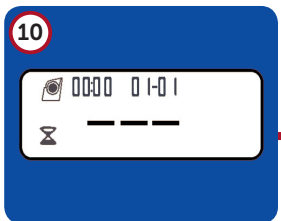
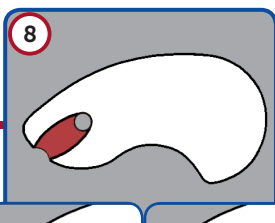
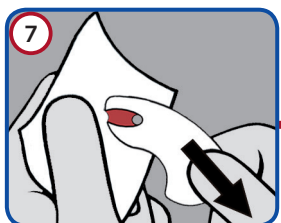

11

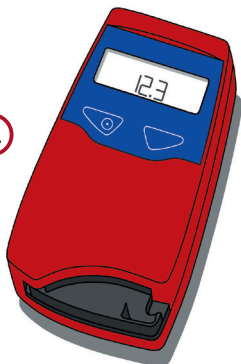

 HEMOCUE[®]

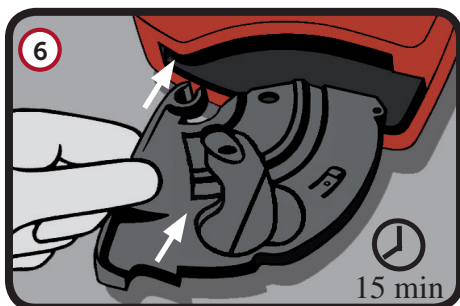
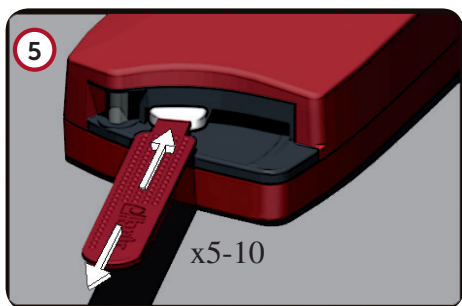
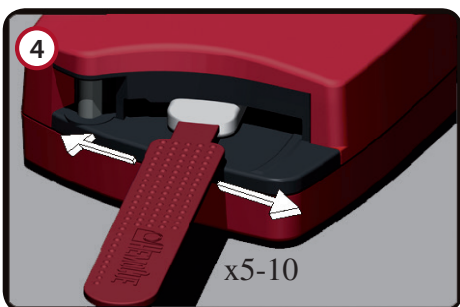
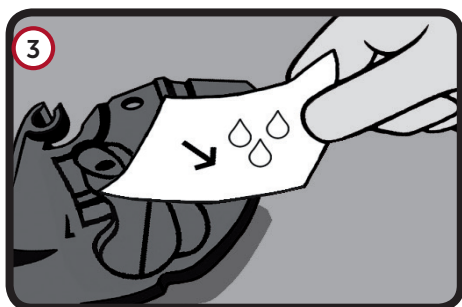
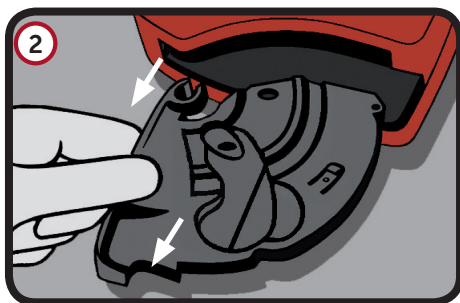

Manufacturer

HemoCue AB
Box 1204
SE-262 23 Ängelholm
Sweden

Phone +46 77 570 02 10
Fax +46 77 570 02 12
E-mail info@hemocue.se
www.hemocue.com

